

HYBRID STEPPING MOTORS

Step degrees 1.8°
Connector types

Transmotec sell a broad range of high quality hybrid stepping motors in standard and customized configurations. Transmotec is the ideal supplier source especially to instrument and apparatus builders. We keep a high number of motors in stock for immediate delivery.

Customizations include:

- ✓ Customized harness
- ✓ Shaft configuration
- ✓ Winding configuration
- ✓ And more...

TABLE OF CONTENTS

Transmotec part name	Step degrees	Flange mm	Length mm	Holding torque Nm	Current phase A	Page
SHC2030-18-060	1.8	20	30.0	0.018	0.60	1.
SHC2033-18-060	1.8	20	33.0	0.018	0.60	1.
SHC2042-18-070	1.8	20	42.0	0.030	0.60	1.
SHC2524-18-070	1.8	25	24.0	0.033	0.70	2.
SHC2832-18-067	1.8	28	32.0	0.065	0.67	3.
SHC2840-18-067	1.8	28	40.0	0.097	0.67	3.
SHC2852-18-067	1.8	28	51.5	0.120	0.67	3.
SHC3538-18-120	1.8	35	38.0	0.230	1.20	4.
SHC3544-18-120	1.8	35	44.0	0.280	1.20	4.
SHC4234-18-133	1.8	42	33.5	0.220	1.33	5.
SHC4240-18-168	1.8	42	39.5	0.360	1.68	5.
SHC4248-18-168	1.8	42	47.5	0.440	1.68	5.
DSH-200	Stepper motor driver				2.00	8.
DSH-300	Stepper motor driver				2.00	9.
DSH-600	Stepper motor driver				2.00	10.
LRS	Power supplies AC-DC					External link

TABLE OF CONTENTS

Transmotec part name	Step degrees	Flange mm	Length mm	Holding torque Nm	Current phase A	Page
SHC5741-18-280	1.8	57	40.5	0.60	2.80	6.
SHC5756-18-280	1.8	57	56.0	1.40	2.80	6.
SHC5775-18-280	1.8	57	76.5	2.30	2.80	6.
SHC6047-18-280	1.8	60	47.0	1.10	2.80	7.
SHC6047-18-280	1.8	60	56.0	1.65	2.80	7.
SHC6067-18-280	1.8	60	67.0	2.10	2.80	7.
SHC6088-18-280	1.8	60	88.0	3.00	2.80	7.
DSH-200	Stepper motor driver				2.00	8.
DSH-300	Stepper motor driver				3.00	9.
DSH-600	Stepper motor driver				6.00	10.
LRS	Power supplies AC-DC					External link

SHC20-18 Series connector □ 20 mm

DRAWING (mm)

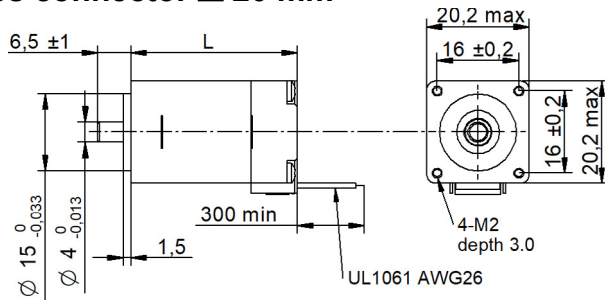

PHOTO



MODEL NAME DESIGNATION

SHW3520 - STEP ANGLE - CURRENT

Example: SHW35-09-100



OPTIONS MOTOR DRIVERS AND POWER SUPPLIES



MOTOR FEATURES

Step angle	1.8
Step angle accuracy	± 5% full step no load
Shaft material	X8CrNiS18-9 SUS303
Bearing type	Ball bearing
Radial play	0.02 mm 450 g
Axial play	0.08 mm 450 g
Max. radial force	10N 20 mm from shaft
Max. axial force	4N
Dielectric strength	600VAC 1 sec.
Insulation resistance	100MΩ 500VDC
Ambient temperature	-20° - (+50°)
Insulation class	Class B
IP rating	IP30
Connection harness	UL 1061 AWG26 300 mm
Connector	CWB ZH-5A

CUSTOMIZATION EXAMPLES

- Shaft configurations
- Bearing type and preload
- Temperature range
- IP rating
- Winding and performance optimization
- Cabling and harness
- Gear box to motor combinations
- Encoder to motor combinations

OPTIONS

- Stepper motor drivers Transmotec DS series
- Power supplies Transmotec LRS series

EXCITATION SEQUENCE TABLE

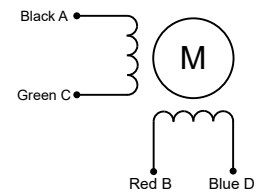

PIN	1	5	2	3
CW	A	C	B	D
1	●		●	
2		●	●	
3		●		●
4	●			●
1	●		●	

● = + Polarity

MOTOR DATA

Graph	A	B	C
Motor model	SHC2030-18-060	SHC2033-18-060	SHC2042-18-060
Holding torque mNm	18	18	30
Detent torque mNm	2.0	2.0	2.0
Rotor inertia gcm ²	2.0	2.0	3.6
Current phase A	0.60	0.60	0.60
Resistance phase Ω	6.50	6.50	5.40
Inductance mH	1.7	1.7	1.5
Length mm	30.0	33.0	42.0
Weight Kg	0.060	0.060	0.080

SPEED | TORQUE PERFORMANCE GRAPH PULL OUT

Graph	A	B	C
Supply voltage VDC	24	24	24
Current phase A	0.60	0.60	0.78

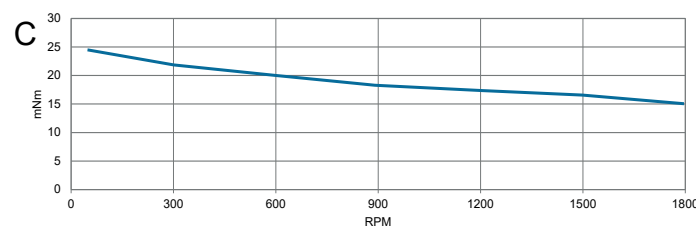
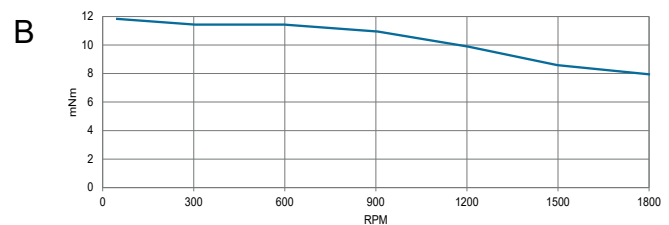
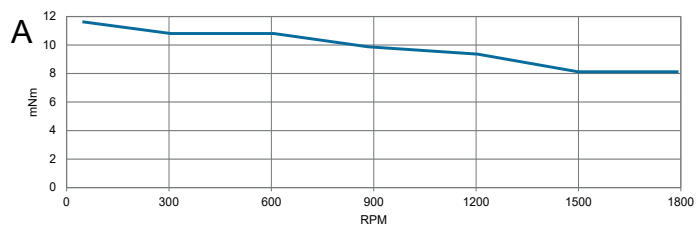

SHC25-18 Series connector □ 25 mm

DRAWING (mm)

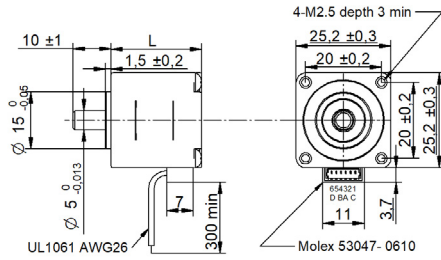

PHOTO



MODEL NAME DESIGNATION

SHC3520 - STEP ANGLE - CURRENT

Example: SHW35-09-100



OPTIONS MOTOR DRIVERS AND POWER SUPPLIES



MOTOR FEATURES

Step angle	1.8
Step angle accuracy	± 5% full step no load
Shaft material	X8CrNiS18-9 SUS303
Bearing type	Ball bearing
Radial play	0.02 mm 450 g
Axial play	0.08 mm 450 g
Max. radial force	28N 20 mm from shaft
Max. axial force	7N
Dielectric strength	600VAC 1 sec.
Insulation resistance	100MΩ 500VDC
Ambient temperature	-20° - (+50°)
Insulation class	Class B
IP rating	IP30
Connection harness	UL 1061 AWG26 300 mm
Connector	Molex 53047-0610

CUSTOMIZATION EXAMPLES

- Shaft configurations
- Bearing type and preload
- Temperature range
- IP rating
- Winding and performance optimization
- Cabling and harness
- Gear box to motor combinations
- Encoder to motor combinations

OPTIONS

- Stepper motor drivers Transmotec DS series
- Power supplies Transmotec LRS series

EXCITATION SEQUENCE TABLE

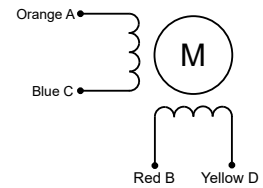

PIN	3	4	1	6
CW	A	C	B	D
1	●		●	
2		●	●	
3		●		●
4	●			●
1	●		●	

● = + Polarity

MOTOR DATA

Graph	A			
Motor model	SHC2524-18-070			
Holding torque mNm	33			
Detent torque mNm	3.0			
Rotor inertia gcm ²	2.0			
Current phase A	0.70			
Resistance phase Ω	4.00			
Inductance mH	2.4			
Length mm	24.0			
Weight Kg	0.055			

SPEED | TORQUE PERFORMANCE GRAPH PULL OUT

Graph	A			
Supply voltage VDC	24			
Current phase A	0.7			

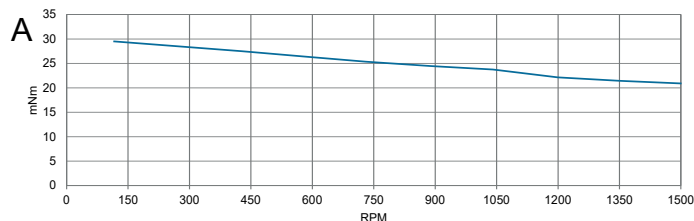

SHC28-18 Series connector □ 28 mm

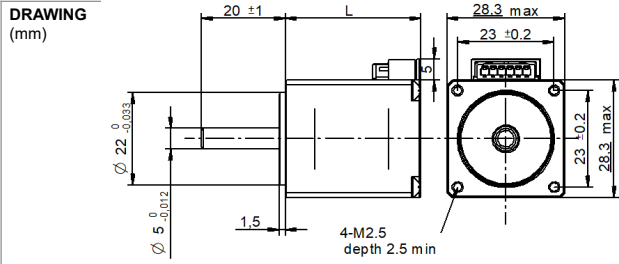

PHOTO

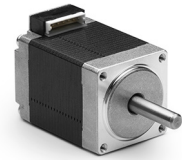

MODEL NAME DESIGNATION

SHW3520 - STEP ANGLE - CURRENT

Example: SHW35-09-100



OPTIONS MOTOR DRIVERS AND POWER SUPPLIES



MOTOR FEATURES

Step angle	1.8
Step angle accuracy	± 5% full step no load
Shaft material	X8CrNiS18-9 303
Bearing type	Ball bearing
Radial play	0.02 mm 400 g
Axial play	0.08 mm 400 g
Max. radial force	28N 5 mm from shaft
Max. axial force	7N
Dielectric strength	600VAC 1 sec.
Insulation resistance	100MΩ 500VDC
Ambient temperature	-20° - (+50°)
Insulation class	Class B
IP rating	IP30
Connection harness	UL1 430 AWG26 300 mm
Connector	Molex 53253-0670

CUSTOMIZATION EXAMPLES

- Shaft configurations
- Bearing type and preload
- Temperature range
- IP rating
- Winding and performance optimization
- Cabling and harness
- Gear box to motor combinations
- Encoder to motor combinations

OPTIONS

- Stepper motor drivers Transmotec DS series
- Power supplies Transmotec LRS series

EXCITATION SEQUENCE TABLE

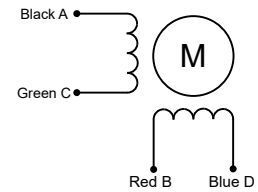

PIN	1	4	3	6
CW	A	C	B	D
1	●		●	
2		●	●	
3		●		●
4	●			●
1	●		●	

● = + Polarity

MOTOR DATA

Graph	A	B	C
Motor model	SHC2832-18-067	SHC2840-18-067	SHC2852-18-067
Holding torque mNm	65	97	120
Detent torque mNm	5.0	6.0	8.0
Rotor inertia gcm ²	9	12	18
Current phase A	0.67	0.67	0.67
Resistance phase Ω	5.60	6.80	9.20
Inductance mH	4.0	4.8	5.6
Length mm	32.0	40.0	51.5
Weight Kg	0.110	0.140	0.200

SPEED | TORQUE PERFORMANCE GRAPH PULL OUT

Graph	A	B	C
Supply voltage VDC	24	24	24
Current phase A	0.67	0.67	0.67

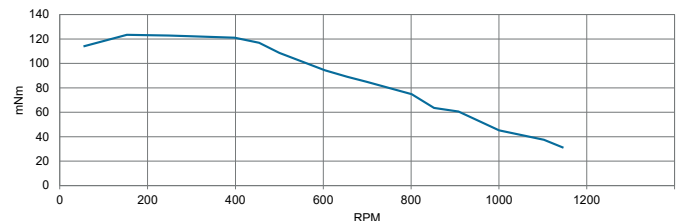
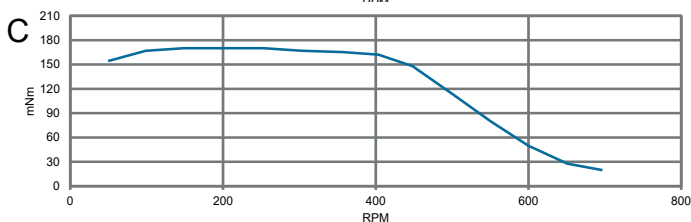
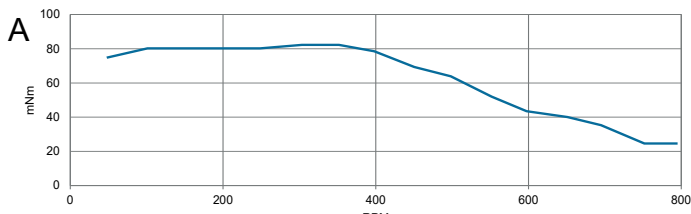

SHC35-18 Series connector □ 35 mm

DRAWING
(mm)

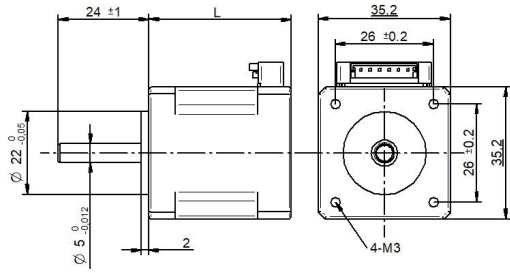

PHOTO

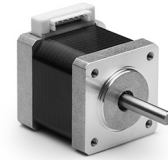

MODEL NAME DESIGNATION

SHW3520 - STEP ANGLE - CURRENT

Example: SHW35-09-100



OPTIONS MOTOR DRIVERS AND POWER SUPPLIES



MOTOR FEATURES

Step angle	1.8
Step angle accuracy	± 5% full step no load
Shaft material	X8CrNiS18-9 303
Bearing type	Ball bearing
Radial play	0.02 mm 450 g
Axial play	0.08 mm 450 g
Max. radial force	28N 20 mm from shaft
Max. axial force	10N
Dielectric strength	600VAC 1 sec.
Insulation resistance	100MΩ 500VDC
Ambient temperature	-20° - (+50°)
Insulation class	Class B
IP rating	IP30
Connection harness	UL 1061 AWG26 300 mm
Connector	JST B6B-EH-A

CUSTOMIZATION EXAMPLES

- Shaft configurations
- Bearing type and preload
- Temperature range
- IP rating
- Winding and performance optimization
- Cabling and harness
- Gear box to motor combinations
- Encoder to motor combinations

OPTIONS

- Stepper motor drivers Transmotec DS series
- Power supplies Transmotec LRS series

EXCITATION SEQUENCE TABLE

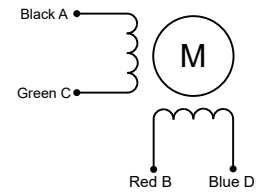

PIN	2	4	3	5
CW	A	C	B	D
1	●		●	
2		●	●	
3		●		●
4	●			●
1	●		●	

● = + Polarity

MOTOR DATA

Graph	A	B		
Motor model	SHC3538-18-120	SHC3544-18-120		
Holding torque mNm	230	280		
Detent torque mNm	18	20		
Rotor inertia gcm ²	20	28		
Current phase A	1.20	1.20		
Resistance phase Ω	3.20	3.20		
Inductance mH	4	5.2		
Length mm	38.0	44.0		
Weight Kg	0.210	0.230		

SPEED | TORQUE PERFORMANCE GRAPH PULL OUT

Graph	A	B		
Supply voltage VDC	24	24		
Current phase A	1.2	1.2		

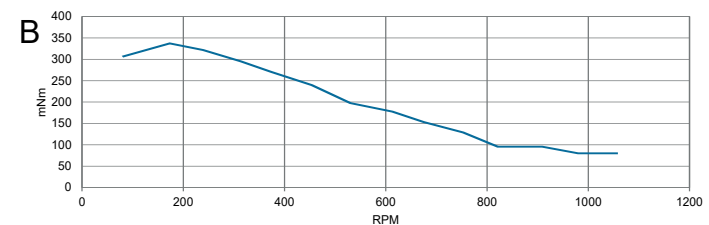
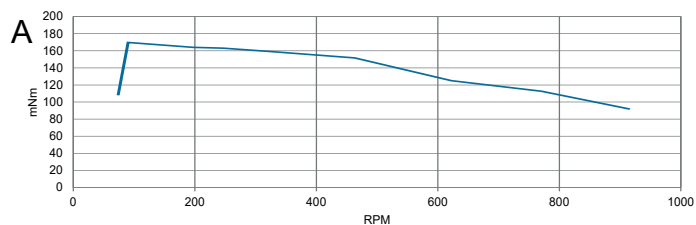

SHC42-18 Series connector □ 42 mm

DRAWING (mm)

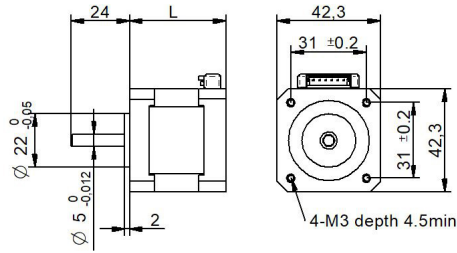

PHOTO

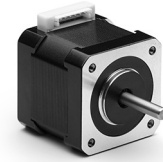

MODEL NAME DESIGNATION

SHW3520 - STEP ANGLE - CURRENT

Example: SHW35-09-100



OPTIONS MOTOR DRIVERS AND POWER SUPPLIES



MOTOR FEATURES

Step angle	1.8
Step angle accuracy	± 5% full step no load
Shaft material	X8CrNiS18-9 303
Bearing type	Ball bearing
Radial play	0.02 mm 450 g
Axial play	0.08 mm 450 g
Max. radial force	28N 20 mm from shaft
Max. axial force	10N
Dielectric strength	600VAC 1 sec.
Insulation resistance	100MΩ 500VDC
Ambient temperature	-20° - (+50°)
Insulation class	Class B
IP rating	IP30
Connection harness	UL 1061 AWG26 300 mm
Connector	JST B6B-EH-A

CUSTOMIZATION EXAMPLES

- Shaft configurations
- Bearing type and preload
- Temperature range
- IP rating
- Winding and performance optimization
- Cabling and harness
- Gear box to motor combinations
- Encoder to motor combinations

OPTIONS

- Stepper motor drivers Transmotec DS series
- Power supplies Transmotec LRS series

EXCITATION SEQUENCE TABLE

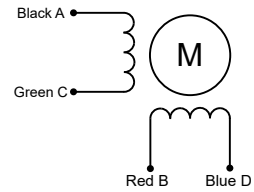

PIN	2	4	3	5
CW	A	C	B	D
1	●		●	
2		●	●	
3		●		●
4	●			●
1	●		●	

● = + Polarity

MOTOR DATA

Graph	A	B	C
Motor model	SHC4234-18-133	SHC4240-18-168	SHC4248-18-168
Holding torque mNm	220	360	440
Detent torque mNm	12	15	20
Rotor inertia gcm ²	35	54	68
Current phase A	1.33	1.68	1.68
Resistance phase Ω	2.10	1.65	1.65
Inductance mH	2.5	3.2	2.8
Length mm	33.5	39.5	47.5
Weight Kg	0.220	0.280	0.350

SPEED | TORQUE PERFORMANCE GRAPH PULL OUT

Graph	A	B	C
Supply voltage VDC	36	36	36
Current phase A	1.36	1.69	1.69

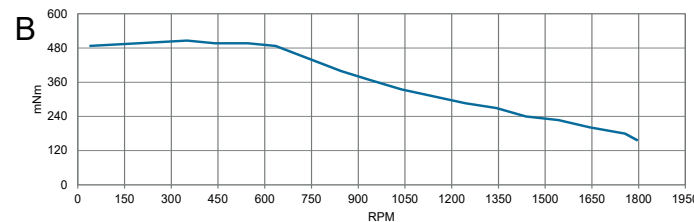
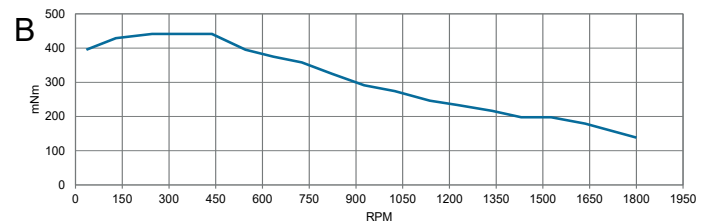
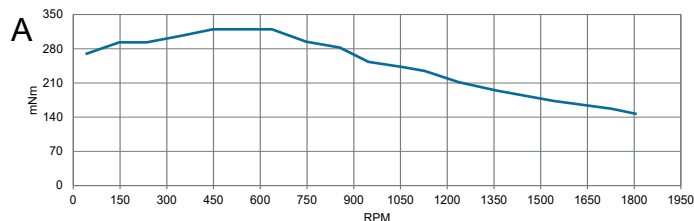

SHC57-18 Series connector □ 57 mm

DRAWING (mm)

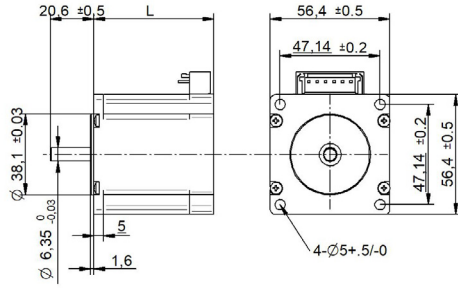

MODEL NAME DESIGNATION

SHW3520 - STEP ANGLE - CURRENT

Example: SHW35-09-100



PHOTO

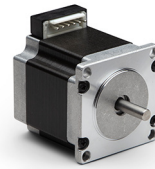

OPTIONS MOTOR DRIVERS AND POWER SUPPLIES



MOTOR FEATURES

Step angle	1.8
Step angle accuracy	± 5% full step no load
Shaft material	X8CrNiS18-9 303
Bearing type	Ball bearing
Radial play	0.02 mm 450 g
Axial play	0.08 mm 450 g
Max. radial force	75N 20 mm from shaft
Max. axial force	15N
Dielectric strength	600VAC 1 sec.
Insulation resistance	100MΩ 500VDC
Ambient temperature	-20° - (+50°)
Insulation class	Class B
IP rating	IP30
Connection harness	UL1430 AWG22 300 mm
Connector	JST B6P-VH

CUSTOMIZATION EXAMPLES

- Shaft configurations
- Bearing type and preload
- Temperature range
- IP rating
- Winding and performance optimization
- Cabling and harness
- Gear box to motor combinations
- Encoder to motor combinations

OPTIONS

- Stepper motor drivers Transmotec DS series
- Power supplies Transmotec LRS series

EXCITATION SEQUENCE TABLE

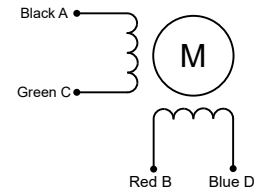

PIN	1	4	3	6
CW	A	C	B	D
1	●		●	
2		●	●	
3		●		●
4	●			●
1	●		●	

● = + Polarity

MOTOR DATA

Graph	A	B	C
Motor model	SHC5741-18-280	SHC5756-18-280	SHC5775-18-280
Holding torque Nm	0.60	1.40	2.30
Detent torque Nm	0.025	0.045	0.070
Rotor inertia gcm ²	120	300	480
Current phase A	2.80	2.80	2.80
Resistance phase Ω	0.78	1.00	1.30
Inductance mH	1.8	3.2	5.3
Length mm	40.5	56.0	76.5
Weight Kg	0.450	0.700	1.100

SPEED | TORQUE PERFORMANCE GRAPH PULL OUT

Graph	A	B	C
Supply voltage VDC	48	48	48
Current phase A	2.8	2.8	2.8

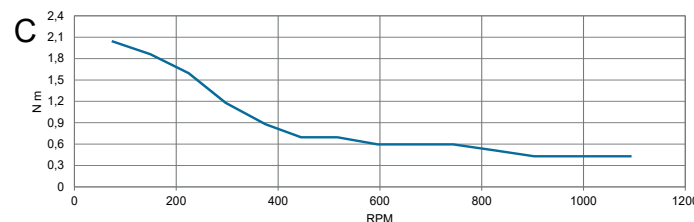
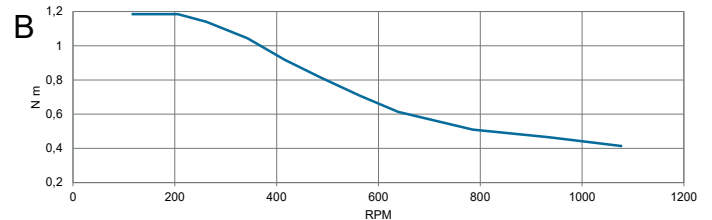
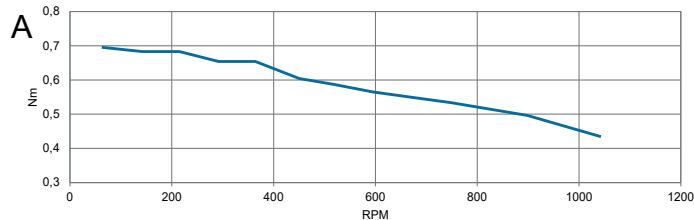

SHC60-18 Series connector □ 60 mm

DRAWING (mm)

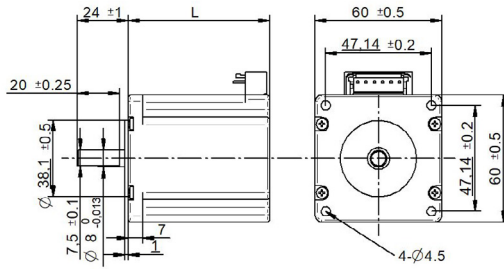

MODEL NAME DESIGNATION

SHW3520 - STEP ANGLE - CURRENT

Example: SHW35-09-100



PHOTO

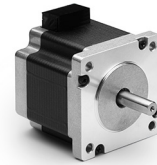

OPTIONS MOTOR DRIVERS AND POWER SUPPLIES



MOTOR FEATURES

Step angle	1.8
Step angle accuracy	± 5% full step no load
Shaft material	X8CrNiS18-9 303
Bearing type	Ball bearing
Radial play	0.02 mm 450 g
Axial play	0.08 mm 450 g
Max. radial force	75N 20 mm from shaft
Max. axial force	15N
Dielectric strength	600VAC 1 sec.
Insulation resistance	100MΩ 500VDC
Ambient temperature	-20° - (+50°)
Insulation class	Class B
IP rating	IP30
Connection harness	UL1430 AWG22 300 mm
Connector	JST B6P-VH

CUSTOMIZATION EXAMPLES

- Shaft configurations
- Bearing type and preload
- Temperature range
- IP rating
- Winding and performance optimization
- Cabling and harness
- Gear box to motor combinations
- Encoder to motor combinations

OPTIONS

- Stepper motor drivers Transmotec DS series
- Power supplies Transmotec LRS series

EXCITATION SEQUENCE TABLE

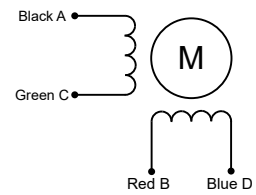

PIN	2	3	4	5
CW	A	C	B	D
1	●		●	
2		●	●	
3		●		●
4	●			●
1	●		●	

● = + Polarity

MOTOR DATA

Graph	A	B	C	D
Motor model	SHC6047-18-280	SHC6056-18-280	SHC6067-18-280	SHC6088-18-280
Holding torque Nm	1.10	1.65	2.10	3.00
Detent torque Nm	0.05	0.07	0.09	0.12
Rotor inertia gcm ²	275	400	570	840
Current phase A	2.80	2.80	2.80	2.80
Resistance phase Ω	0.75	0.90	1.20	1.50
Inductance mH	2	3.6	4.6	6.8
Length mm	47.0	56.0	67.0	88.0
Weight Kg	0.600	0.770	1.200	1.400

SPEED | TORQUE PERFORMANCE GRAPH PULL OUT

Graph	A	B	C	D
Supply voltage VDC	48	48	48	48
Current phase A	2.7	2.7	2.7	2.7

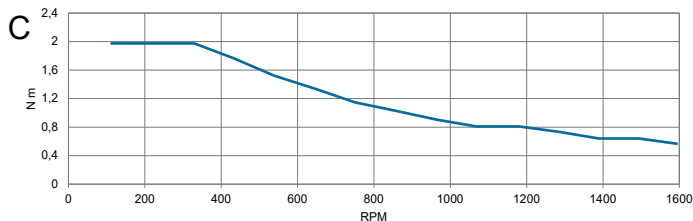
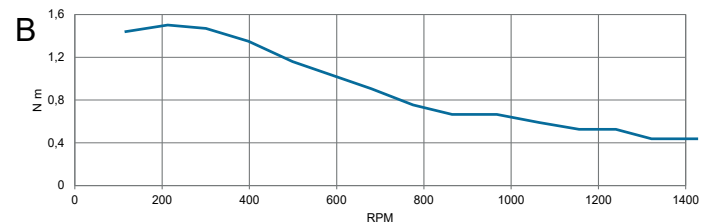
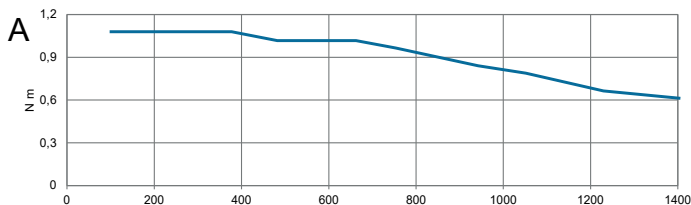

D

DSH-200

DRAWING (mm)

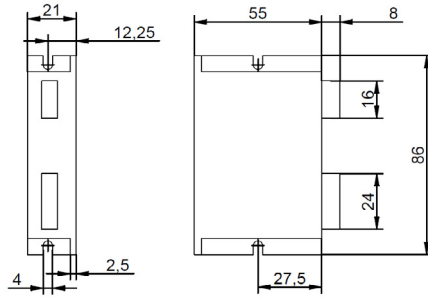

MODEL NO. DESIGNATION

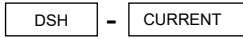

Example: DSH-200

PHOTO



OPTIONS POWER SUPPLIES LRS SERIES



GENERAL

Model	Current	Weight	IP	Temperature range	Accessories
DSH-200	2.2 A	0.10 Kg	IP20	0 - 50 °C	Power supplies series Transmotec LRS series

FUNCTIONS

ALARM PWR	LED indicators	Green LED on Red LED on	Power on Fault detection
+5V	Control signal positive power		
DIR	Motor direction signal	+5 V CW rotational direction	0 V CCW rotational direction
PUL	Pulse signal	Driver input clock pulses (LO=0V, HI=5V)	Max pulse frequency 200 kHz
MF	Motor enable signal	+5 V to enable rotation	0 V to disable rotation
A- A+ B- B+		Motor phases connection	-
V+ V-		Power supply 18-36 VDC GND	

Note +5V = signal voltage | +5VDC= continuous supply voltage

CURRENT LIMIT SWITCH SETTINGS

Current RMS A	0.2	0.4	0.5	0.7	0.9	1.1	1.4	1.6
Current peak A	0.3	0.5	0.7	1.0	1.3	1.6	1.9	2.2
SW1	ON	OFF	ON	OFF	ON	OFF	ON	OFF
SW2	ON	ON	OFF	OFF	ON	ON	OFF	OFF
SW3	ON	ON	ON	ON	OFF	OFF	OFF	OFF

MICRO-STEP SWITCH SETTINGS

Micro-step/step	1	8	16	32
PUL/REV	200	1600	3200	6400
SW5	ON	OFF	ON	OFF
SW6	ON	ON	OFF	OFF

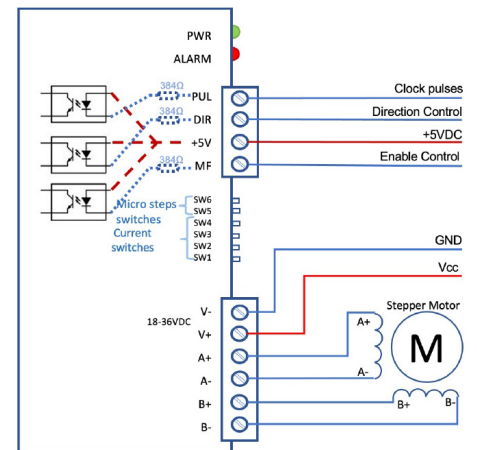

FUNCTION SWITCH SETTINGS

	ON-SETTING	OFF-SETTING
SW4	Full and half current	Full current always
		Half current when pulse time ≥ 200 ms

DSH-300

DRAWING (mm)

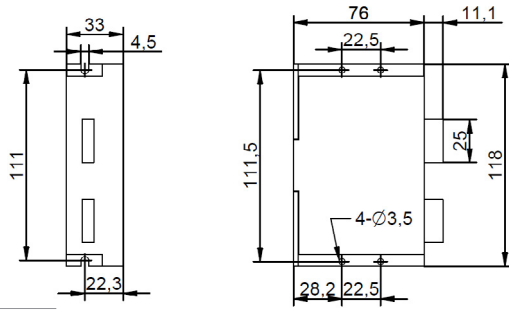

MODEL NO. DESIGNATION

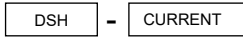

Example: DSH-300

PHOTO



OPTIONS POWER SUPPLIES LRS SERIES



GENERAL

Model	Current	Weight	IP	Temperature range	Accessories
DSH-300	3 A	0.25 Kg	IP20	0 - 50 °C	Power supplies series Transmotec LRS series

FUNCTIONS

ALARM PWR	LED indicators	Green LED on Green LED flashes	Power on Fault detection
DIR-	Motor direction signal	+5 V CW rotational direction	0 V CCW rotational direction
DIR+	Motor direction Vcc	+5 VDC to enable direction control	-
PUL-	Pulse signal	Driver input clock pulses (LO=0V, HI=5V)	Max pulse frequency 200 kHz
PUL+	Pulse Vcc	+5 VDC to enable clock pulses	-
MF-	Motor enable signal	+5 V to enable rotation	0 V to disable rotation
MF+	Motor enable Vcc	+5 VDC to enable the enable operation	-
A- A+ B- B+		Motor phases connection	-
V+ V-		Power supply 20-50 VDC GND	-

Note +5V = signal voltage | +5VDC= continuous supply voltage

CURRENT LIMIT SWITCH SETTINGS

Current RMS A	0.7	1.0	1.4	1.7	2.0	2.4	2.7	3.0
Current peak A	1.0	1.5	1.9	2.4	2.8	3.3	3.8	4.2
SW1	ON	OFF	ON	OFF	ON	OFF	ON	OFF
SW2	ON	ON	OFF	OFF	ON	ON	OFF	OFF
SW3	ON	ON	ON	ON	OFF	OFF	OFF	OFF

MICRO-STEP SWITCH SETTINGS

Micro-step/step	2	4	8	16	32	64	128	5	10	20	25	40	50	100	200
PUL/REV	400	800	1.6K	3.2K	6.4K	12.8K	25.6K	1K	2K	4K	5K	8K	10K	20K	40K
SW5	OFF	ON	OFF	ON	OFF	ON	OFF	ON	OFF	ON	OFF	ON	OFF	ON	OFF
SW6	ON	OFF	OFF	ON	ON	OFF	OFF	ON	ON	OFF	OFF	ON	ON	OFF	OFF
SW7	ON	ON	ON	OFF	OFF	OFF	OFF	ON	ON	ON	ON	OFF	OFF	OFF	OFF
SW8	ON	ON	ON	ON	ON	ON	ON	OFF	OFF	OFF	OFF	OFF	OFF	OFF	OFF

FUNCTION SWITCH SETTINGS

	ON-SETTING	OFF-SETTING
SW4	Full and half current	Full current always
		Half current when pulse time ≥ 200 ms

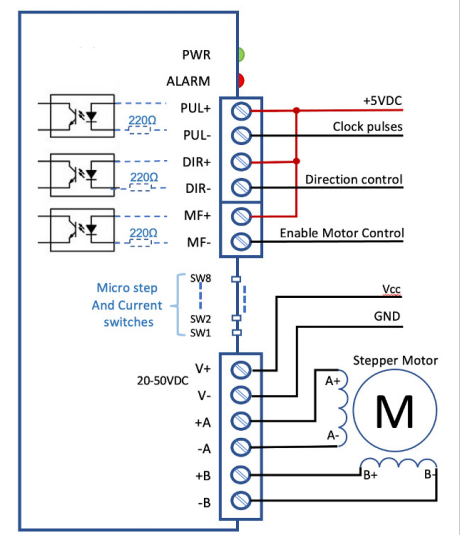

DSH-600

DRAWING (mm)

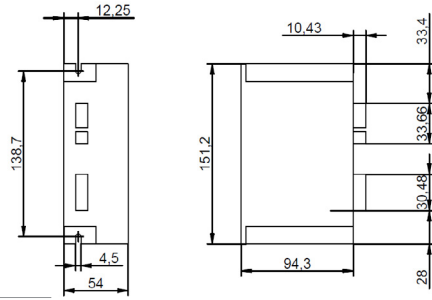

MODEL NO. DESIGNATION

DSH - CURRENT

Example: DSH-600

PHOTO



OPTIONS POWER SUPPLIES LRS SERIES



GENERAL

Model	Current	Weight	IP	Temperature range	Accessories
DSH-600	6 A	0.60 Kg	IP20	0 - 50 °C	Power supplies series Transmotec LRS series

FUNCTIONS

ALARM PWR	LED indicators	Green LED on Green LED flashes Red LED 2 flashes / 3 seconds Red LED 3 flashes / 3 seconds Red LED 4 flashes / 3 seconds	Motor disabled Motor enabled Undervoltage Overvoltage Overcurrent
DIR-	Motor direction signal	+5 V CW rotational direction	0 V CCW rotational direction
DIR+	Motor direction Vcc	+5 VDC to enable direction control	-
PUL-	Pulse signal	Driver input clock pulses	Max pulse frequency 200 kHz
PUL+	Pulse Vcc	+5 VDC to enable clock pulses	-
MF-	Motor enable signal	+5 V to enable rotation	0 V to disable rotation
MF+	Motor enable Vcc	+5 VDC to enable the enable operation	-
A- A+ B- B+		Motor phases connection	-
DC AC		Power supply 24-110 VDC polarity any 18-80 VAC	

Note +5V = signal voltage | +5VDC= continuous supply voltage

CURRENT LIMIT SWITCH SETTINGS

Current RMS A	2.00	2.57	3.14	3.71	4.28	4.86	5.43	6.00
Current peak A	2.40	3.08	3.77	4.45	5.14	5.83	6.52	7.20
SW1	ON	OFF	ON	OFF	ON	OFF	ON	OFF
SW2	ON	ON	OFF	OFF	ON	ON	OFF	OFF
SW3	ON	ON	ON	ON	OFF	OFF	OFF	OFF

MICRO-STEP SWITCH SETTINGS

Micro-step/step	2	4	8	16	32	64	128	256	5	10	20	25	40	50	100	200
PUL/REV	400	800	1.6K	3.2K	6.4K	12.8K	25.6K	51.2K	1K	2K	4K	5K	8K	10K	20K	40K
SW5	ON	OFF	ON	OFF	ON	OFF	ON	OFF	ON	OFF	ON	OFF	ON	OFF	ON	OFF
SW6	ON	ON	OFF	OFF	ON	ON	OFF	OFF	ON	ON	OFF	OFF	ON	ON	OFF	OFF
SW7	ON	ON	ON	ON	OFF	OFF	OFF	OFF	ON	ON	ON	ON	OFF	OFF	OFF	OFF
SW8	ON	ON	ON	ON	ON	ON	ON	ON	OFF	OFF	OFF	OFF	OFF	OFF	OFF	OFF

FUNCTION SWITCH SETTINGS

		ON-SETTING	OFF-SETTING
SW4	Full and half current	Full current always	Half current when pulse time ≥ 200 ms
SW9	Pulse Smoothing	Motor accelerate and decelerate smoothly	Regular acceleration and deceleration
SW10	N/A	N/A	N/A
SW11	Pulse filter	Enabled low pass filter ≤ 400 Hz	Enabled low pass filter ≤ 100 Hz
SW12	N/A	N/A	N/A
SW13	Pulse mode not supported	Always off	Always off
SW14	Self-test	Connect only driver and power to motor. Motor should run by internal puses at 5 kHz	Normal connection

